



A Beginners Guide to Installing DCC Decoders

By Mark Schutzer

PCR Regional Convention, San Luis Obispo

May 2014

Copies of this presentation can be found at

<http://www.markschutzer.com>

Clinic Overview



Installing DCC decoders

- This clinic will show beginners how to install DCC decoders in both Steam and Diesel locomotives.
- After presenting some general decoder information I will guide you through a step by step installation example in both Steam and Diesel locomotives.
- Some advanced sound decoders will also be discussed

DCC Decoders Overview



Electrical pickup review for steam locomotives

Typical Instructions

Motors

Decoder selection – size, type, and current rating

Lighting – Incandescent bulbs and LED's

Connectors and wiring techniques

Steam and Diesel installation examples

Advanced installations - Sound

More examples...

Sources

Electrical Pickup – Steam Locomotives



Locomotive Frame is connected to right rail.

Tender Frame is connected to left rail.

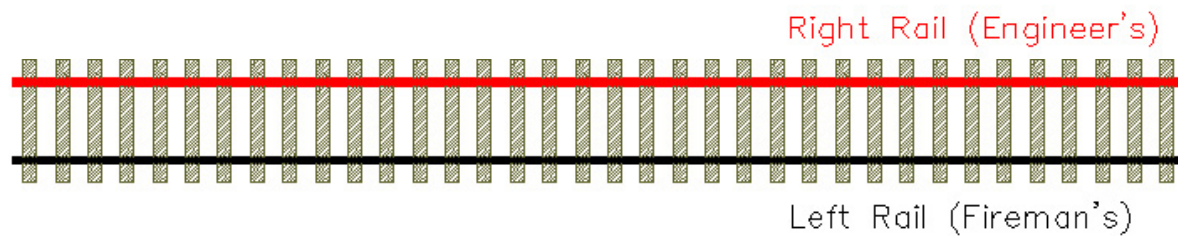
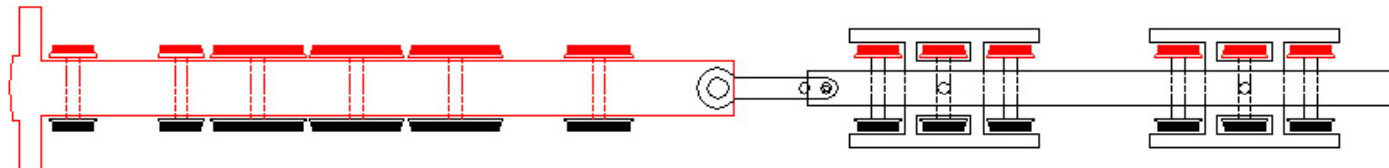

Typical Instructions



Generic Instructions

- Mount decoder
- Isolate motor contacts from track and frame
- Wire motor connections
 - Red wire to right rail, Orange wire to motor positive
 - Black wire to left rail, Grey wire to motor negative
- Replace 1.5 volt bulbs or add limiting resistors
- Wire lighting circuits
 - Blue wire is positive common for all function outputs
 - White wire is headlight output (F0 forward)
 - Yellow wire is rear light output (F0 reverse)
 - Green wire is F1 output (if supported)
 - Violet wire is F2 output (if supported)
- Test on the programming track
- Program as desired...

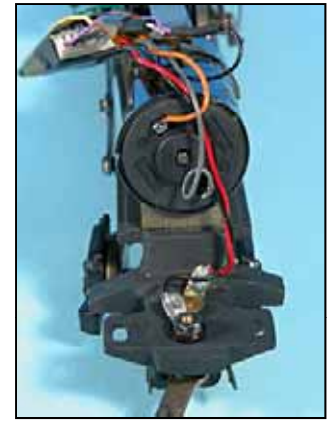

Decoder Wiring

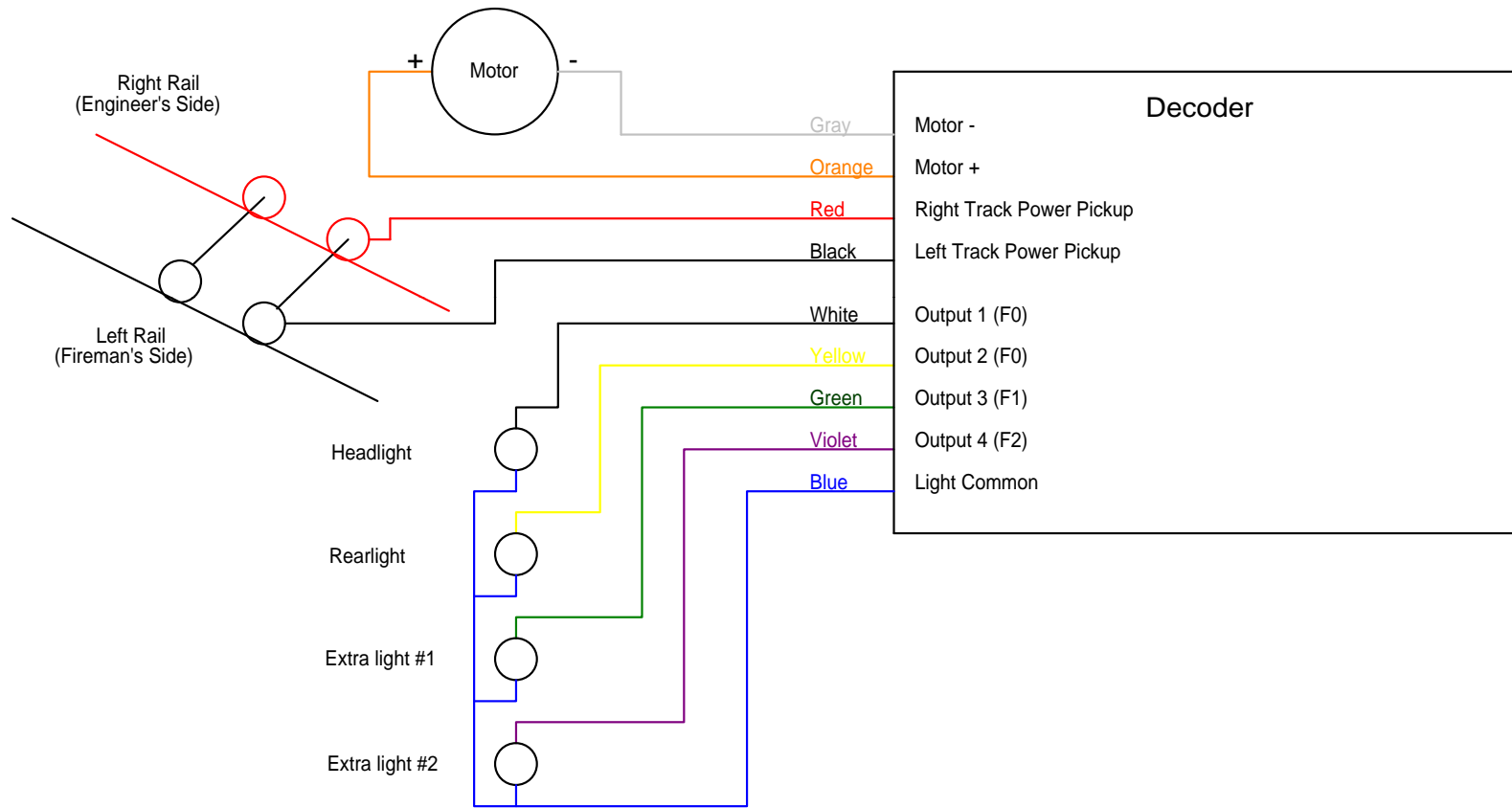



Motors – Early Brass Locos

Original Motors



Original Motors

- Most early motors are open frame types
- Poor slow speed operation
- High starting voltage and current
- Not very efficient
- High slip and stall currents
- Require a higher rated decoder, costing more money \$\$\$
- Sometimes require work to isolate from frame

- Replacement strongly recommended!

Original Motors



Some typical open frame motor numbers

| Motor Type Open Frame KTM | Free Running Current (Amps) 12 volts | Typical loaded Current (Amps) 12 volts | Stall Current (Amps) 12 volts |
|---------------------------------|--|--|-------------------------------------|
| Small | 0.6 | 1.0 or more | 2.0 |
| Medium | 0.6 | 1.2 or more | 2.9 – 3.0 |
| Large | 0.7 | 1.5 or more | > 3.5 |

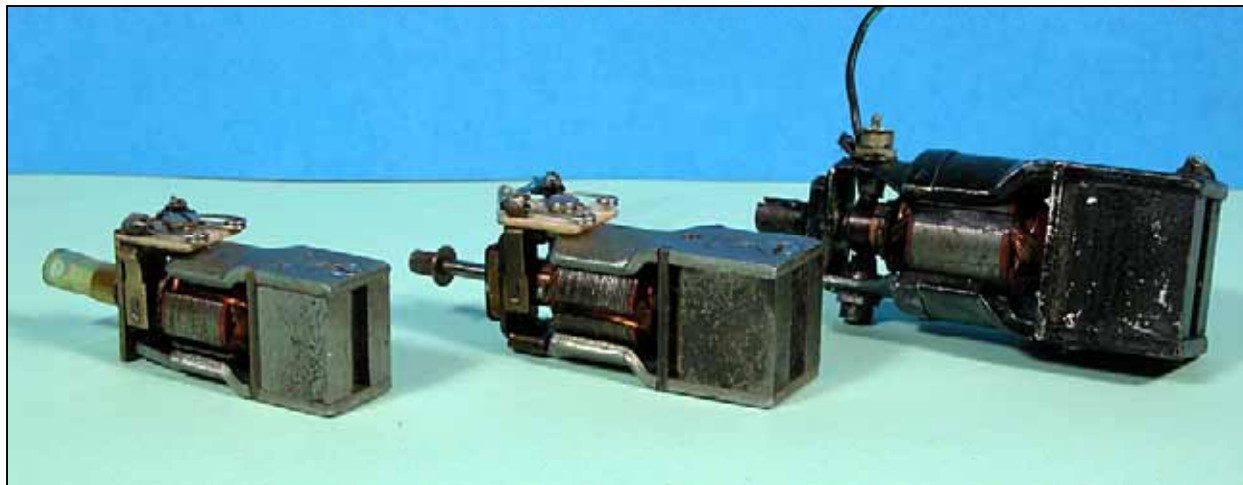

Can Motors



Can motor advantages

- More efficient, much lower current draw
- Most are skew wound for very good slow speed performance
- Slower starting speeds and excellent slow speed torque
- Better slow speed performance allows lower gearbox ratios to be used reducing the top end noise.
- DCC friendly; isolated terminals, and most HO sized motors have stall currents under or about 1 amp.



Can Motors



Some typical can motor numbers

| Motor Type NWSL | Free Running Current (Amps) 12 volts | Max. Continuous Current (Amps) 12 volts | Stall Current (Amps) 12 volts | Stall Torque (Oz.-in.) |
|--------------------|--|---|-------------------------------------|---------------------------|
| 12270-9 | 0.08 | 0.25 | 0.54 | 0.61 |
| 16307-9 | 0.05 | 0.34 | 0.95 | 0.79 |
| 18367-9 | 0.19 | 0.40 | 1.20 | 2.50 |
| 20324-9 | 0.05 | 0.36 | 0.90 | 1.40 |

N scale decoders okay for all of these!

- 1 amp continuous rated

Selecting a decoder



Choices, choices, choices...

- Decoder rating should be in excess of full slip current at 12 volts
- Sized to fit locomotive
- Feature selection
 - Number of lighting outputs
 - Silent running
 - Torque compensation
 - Back EMF; also known as load compensation
 - Advanced consist support
 - Automation features
 - Sound, Tsunami, Micro Tsunami
- Choose your favorite supplier
- Lots of decoders rated in the 1.0 to 1.3 amp range

Lighting



Lighting

- Function outputs are used for lights
- Function 0 is direction sensitive and has 2 outputs associated with it by default. Controls headlight and back up light.
- Almost all decoders have at least 2 function outputs, many have 4 outputs or more.
- Most decoders support a variety of special lighting effects.
- Decoders supply 12.5 volts to the lights
- Modify existing bulbs, several options...
 - Add resistor in line with 1.5 volt bulbs
 - Replace 1.5 volt bulbs with 14 volt bulbs
 - Replace 1.5 volt bulb with sunny white LED and 1k resistor
- Use a spare lighting output to provide a firebox flickering effect.

Lighting



Lamps and Resistors

| Lamp Type | Current | Resistor |
|--------------------|--------------------|--|
| 12 to 14 volt bulb | < 50 mA > 50 mA | None 22 ohm, 1/4 Watt |
| 1.5 volt bulb | 15 mA 30 mA | 820 ohm, 1/4 Watt 390 ohm, 1/2 Watt |
| White LED | 10 mA | 1000 ohm, 1/4 Watt |

Wiring



Wiring techniques

- Install decoder so that boiler can be easily removed
 - Use connectors on wires inside of boiler (headlight)
 - If decoder is captive in boiler use connectors for everything
 - Use connectors for all boiler to tender wiring
- Solder all wire connections
 - Use a water, or Rosin based flux (Not acid based!)
 - Clean off flux with water, or isopropyl alcohol
- Use heat shrink tubing on all exposed connections to keep the wiring both insulated and neat. Get several different sizes.

Connectors



Connectors

- Available from Miniaturics
 - Expensive, \$10 dollars for a pair of 2 pin connector sets
- Easy to make from low cost pin strips and sockets
 - Several sizes available
 - Pin spacings of 0.1 inch, 2 mm, 0.05 inches
 - 40 pin strips are best cost value, about \$2 dollars each
 - Cut to the number of pins needed
- Solder wire to pin leads and insulate with heat shrink tubing

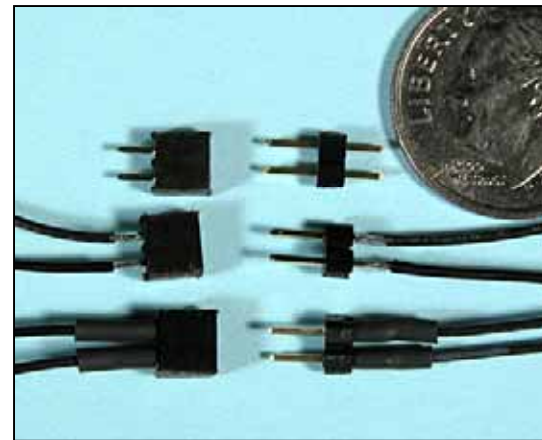
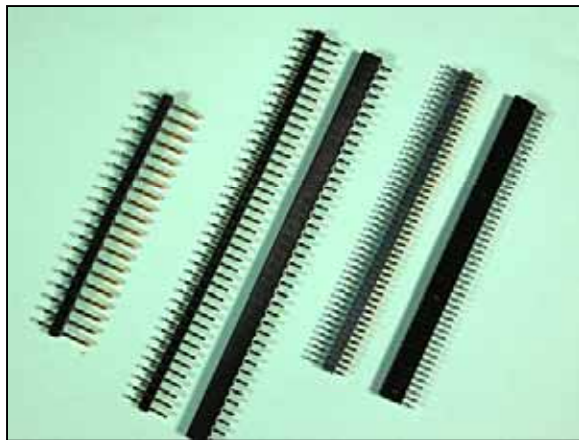



Steam Installation Example

Decoder Installation Example



Decoder Installation – Max Gray, Ten Wheeler



Boiler Removal



Removing the boiler

- The boiler is usually secured to the frame with three screws.
- The front screw usually also secures the pilot trucks in place.
- The two rear screws are either under the cab, or in this case in the back wall of the cab.
- Remove the two cab screws and the pilot truck mounting stud to loosen the boiler.



Boiler Removed



Boiler Removed

- Note motor wiring, identify right and left rail connections.
- Note headlight connector.

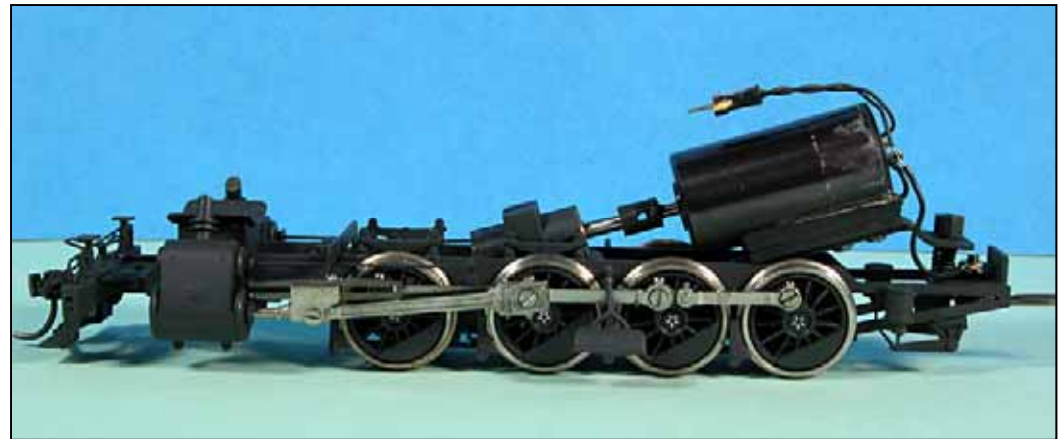
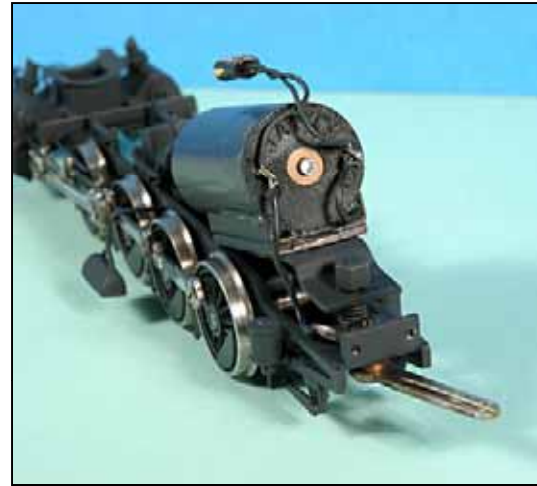

Decoder Fitting



Test fit selected decoder

- Decoder N14SR
- Test fit decoder to determine ideal position.
- Usually place decoder on top of motor.
- With decoder in place verify boiler clearance, adjust location as needed.

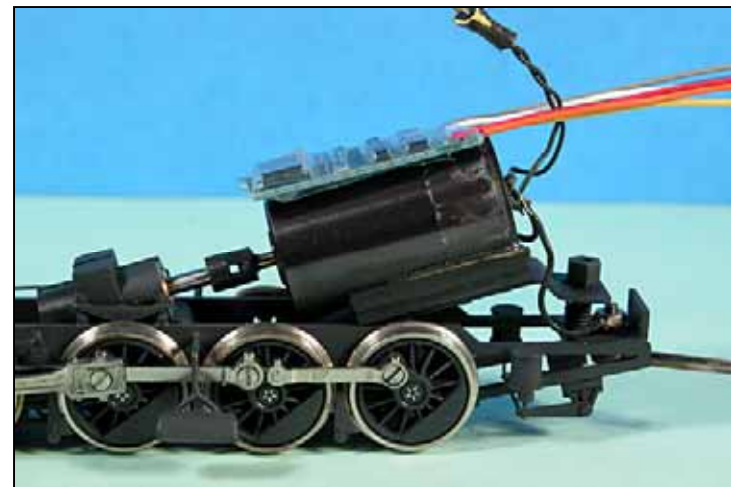
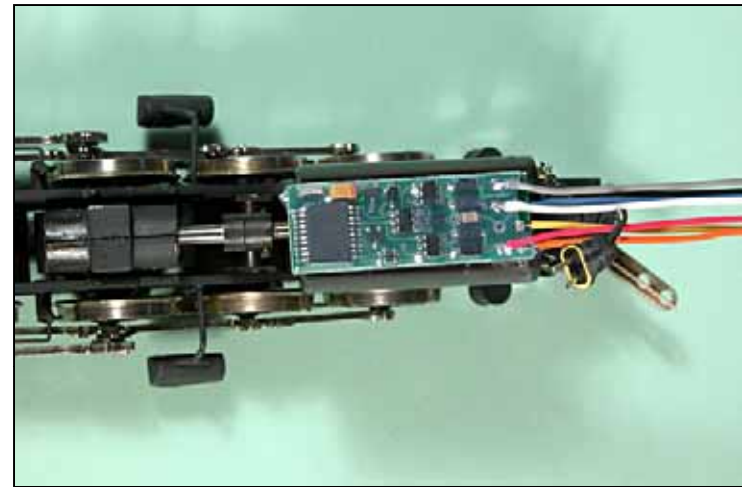

Decoder Preparation



Preparing Decoder

- Original decoder shown to right.
- Add resistor to headlight connector.
- Solder headlight connector to decoder.
- Solder firebox flicker light to decoder.
- Use heat shrink tubing to insulate connections.
- Heat shrink decoder (if not already)

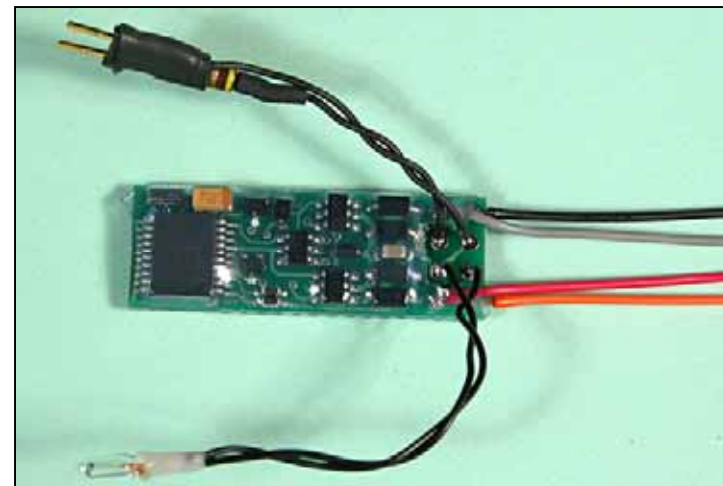
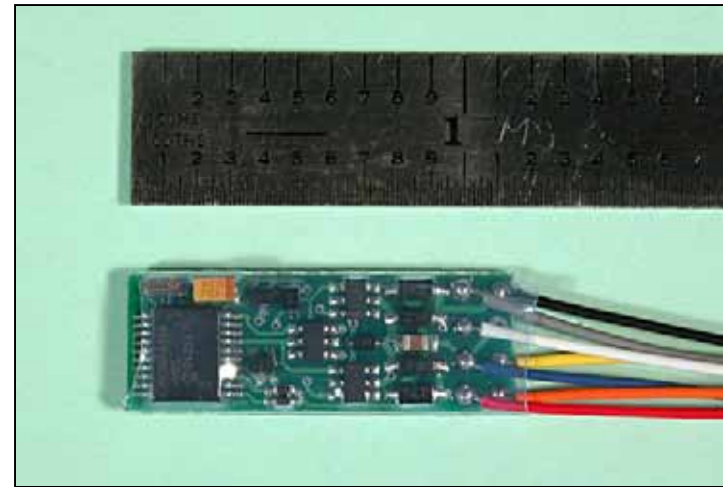

Motor Wiring



Wiring Motor Connections

- Reference original motor connections.
- Connect red wire to right side pickup (locomotive frame).
- Connect orange wire to the motor terminal that was connected to the right side rail (frame connection).
- Connect black wire to the tender drawbar.
- Connect grey wire to the motor terminal that was connected to the tender drawbar.

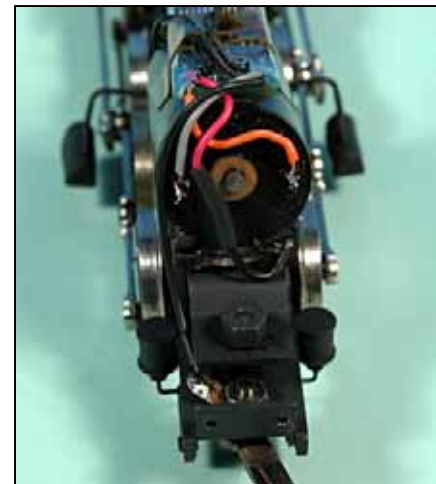

Installing



Secure decoder with Kapton tape or electrical tape.
Place firebox flicker light in position.
Test first on programming track, and then on main.
Reinstall boiler to complete.
Recheck operation.

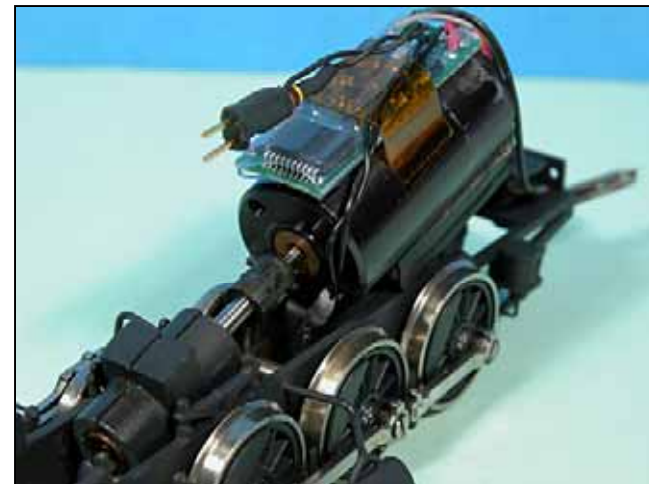
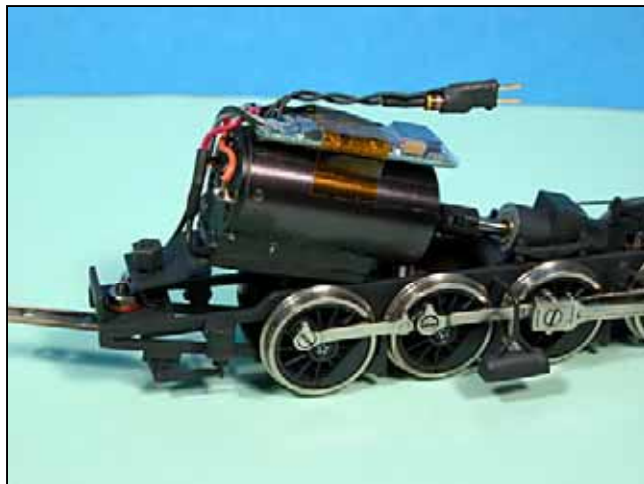
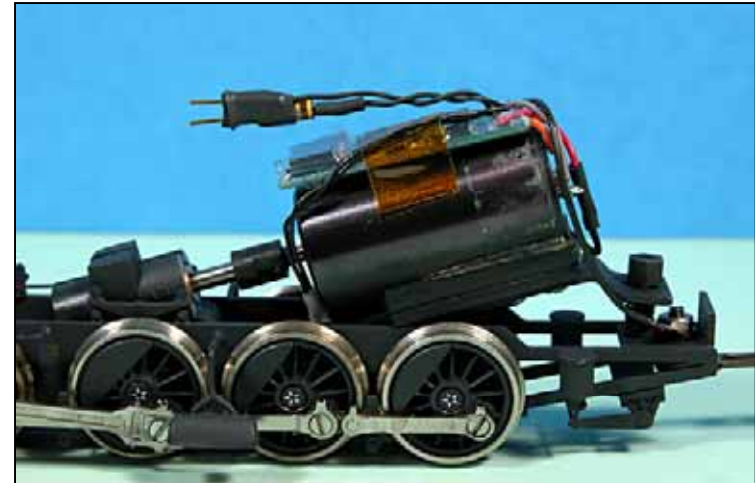

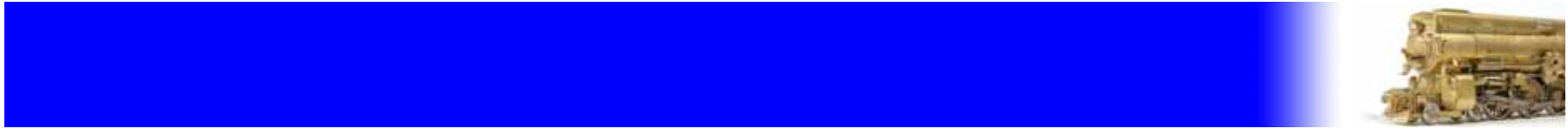

Diesel Installation Example

Decoder Installation Example - Diesel



Decoder Installation – Stewart – F7



Shell Removal



Removing the shell

- Remove the front coupler retainer and remove the front coupler.
- Gently pry the shell apart along the bottom and remove the shell.

Wiring Board Removal



Wiring Board Removal

- Remove 2 screws, unplug all the connectors
- Slip motor connections from underneath retainer wires
- Remove board and discard

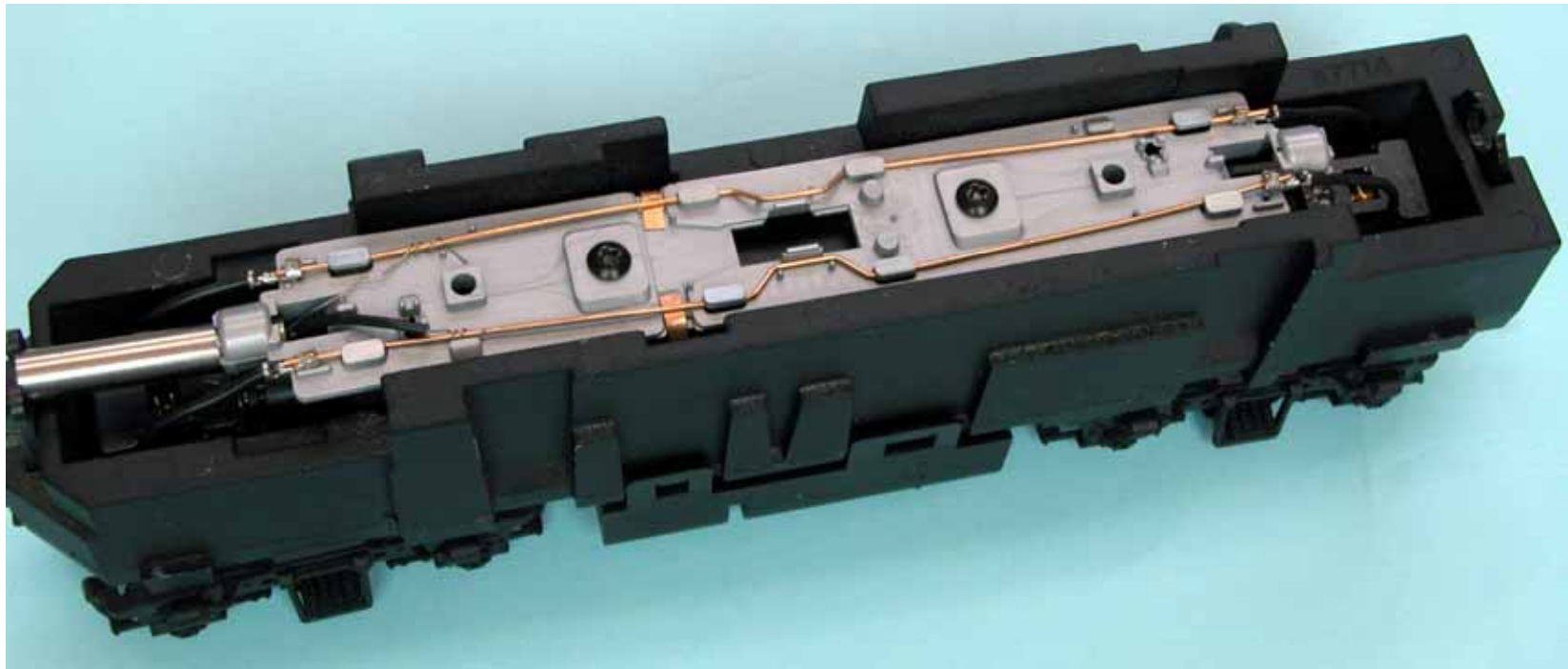

Wiring Board Removal



Wiring Board Removed

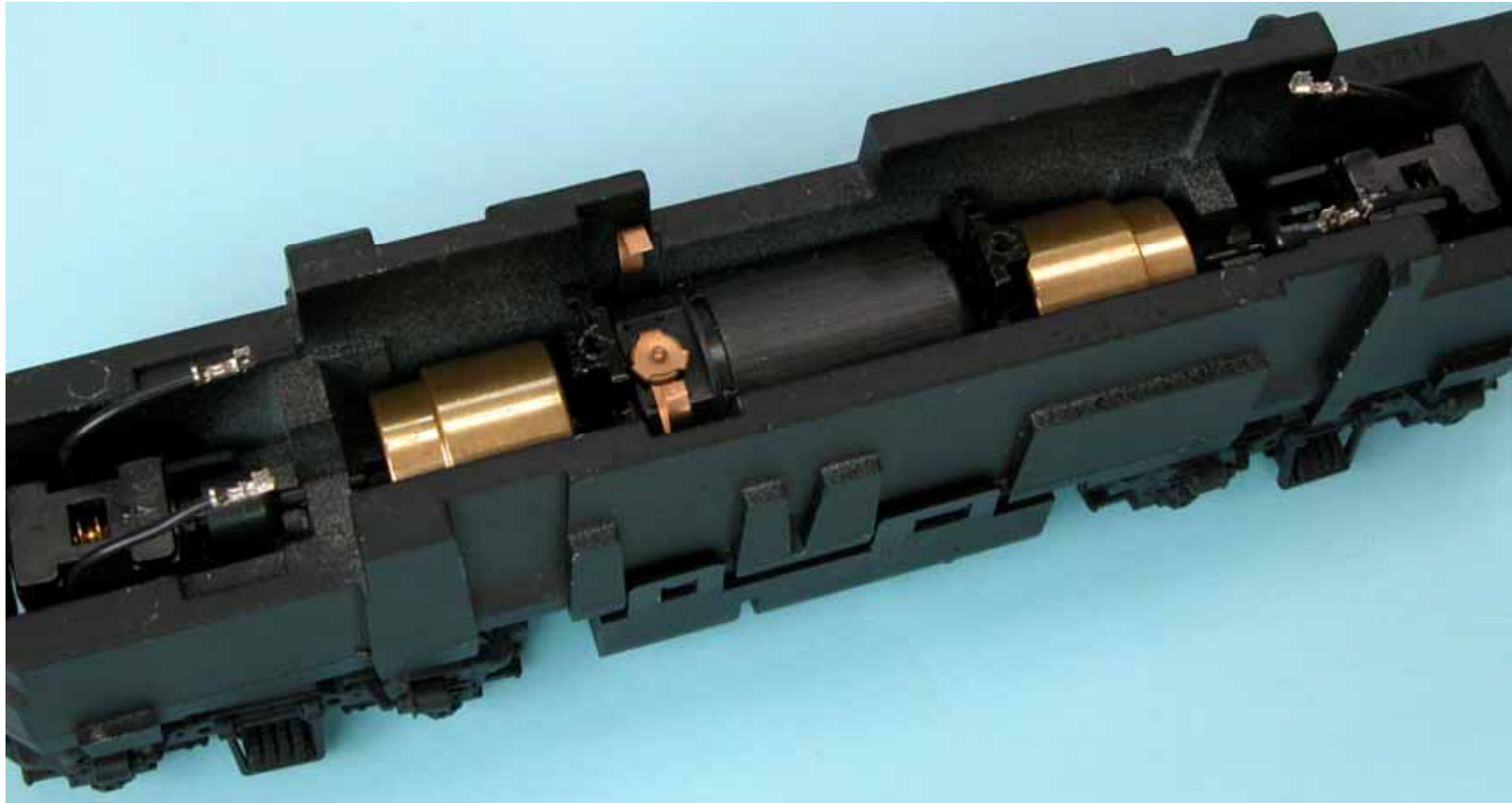

Decoder Features



NCE DASR

Atlas GP38, GP40, RS1/2/3, C424/5, GP7, RSD4/5/12, C30-7, U23B, U33/36C
Athearn "Genesis" series locomotives; F7, F3, SD70, SD75, SD80, etc
Kato GP35, SD40, C44-9W Stewart AS16, F3A, F3B, F7A, F7B, F9A, F9B, U25B

This is an EPF (extended packet format) decoder supporting:

- ✓ Silent Running™ motor drive
- ✓ Improved DC operation (with lighting effects)
- ✓ Torque Compensation (dither) for ultra smooth low speed performance
- ✓ Programmable Start, Mid and Maximum speed works for all speed modes
- ✓ Motor rating 1.3 Amp continuous, 2 Amp peak (stall)
- ✓ All five function outputs have lighting effects generators
- ✓ Select from 15 different lighting effects (Mars, strobes, beacon, flicker, etc)
- ✓ Lighting outputs can be mapped to different functions
- ✓ Uploadable speed table interpolated to 128 speed steps
- ✓ Decoder assisted consist
- ✓ Support for all forms of DCC programming
- ✓ Decoder programming lock mechanism
- ✓ Brake on DC feature assists automatic train control

Decoder Selection



Connection diagram

- NCE DASR
- Connection diagram shown below.

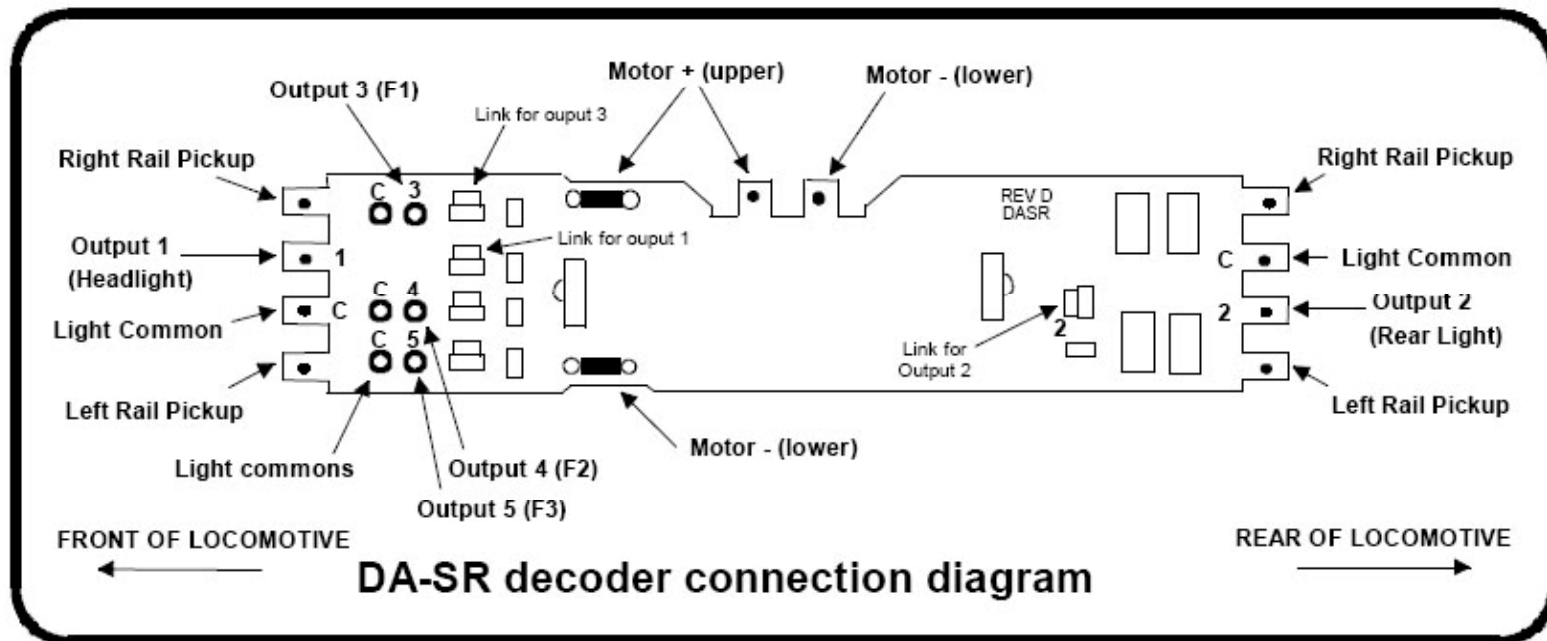

Decoder Fitting



Fit selected decoder

- Decoder NCE DASR, or any Atlas form factor decoder
- Use original screws to secure
- Solder motor tabs to traces on board.
- Solder wire extensions to truck pickup wires

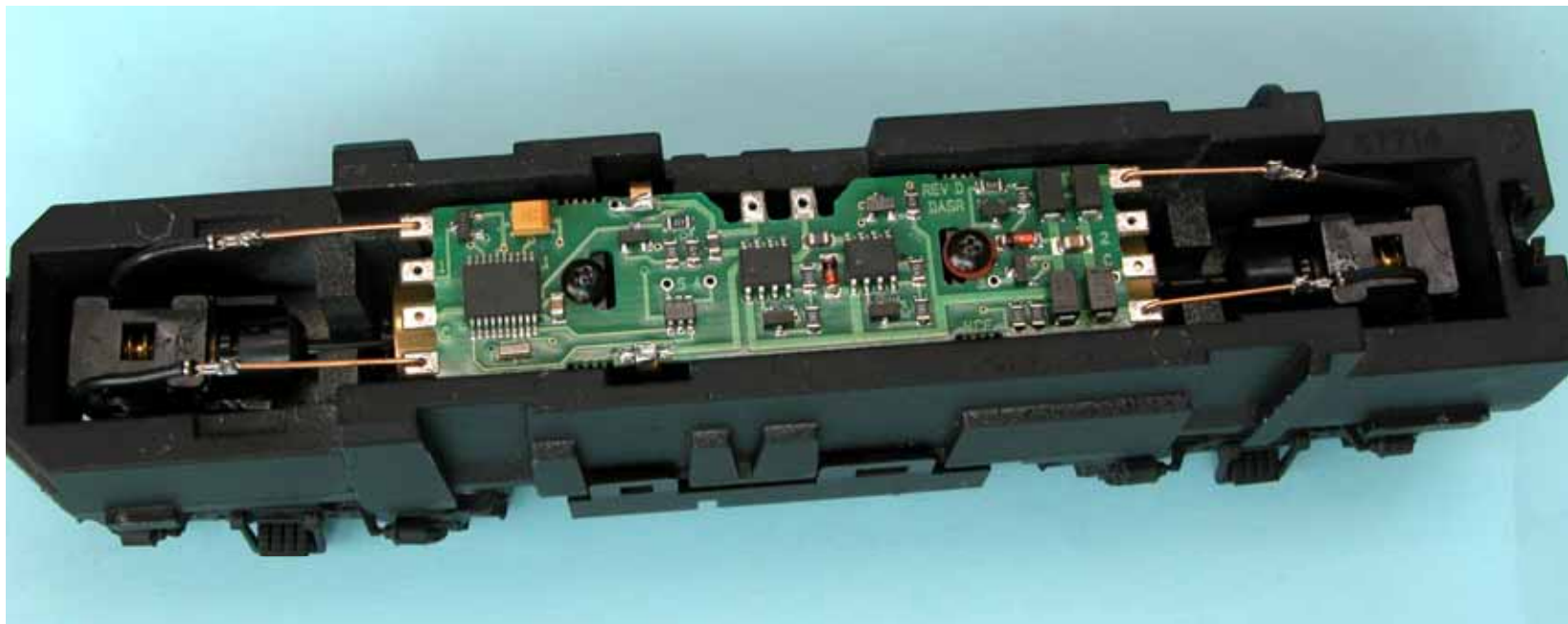

Decoder Fitting



Fitting decoder

- Apply heat shrink tubing over exposed wires before soldering
- Solder pickup wire connections in place

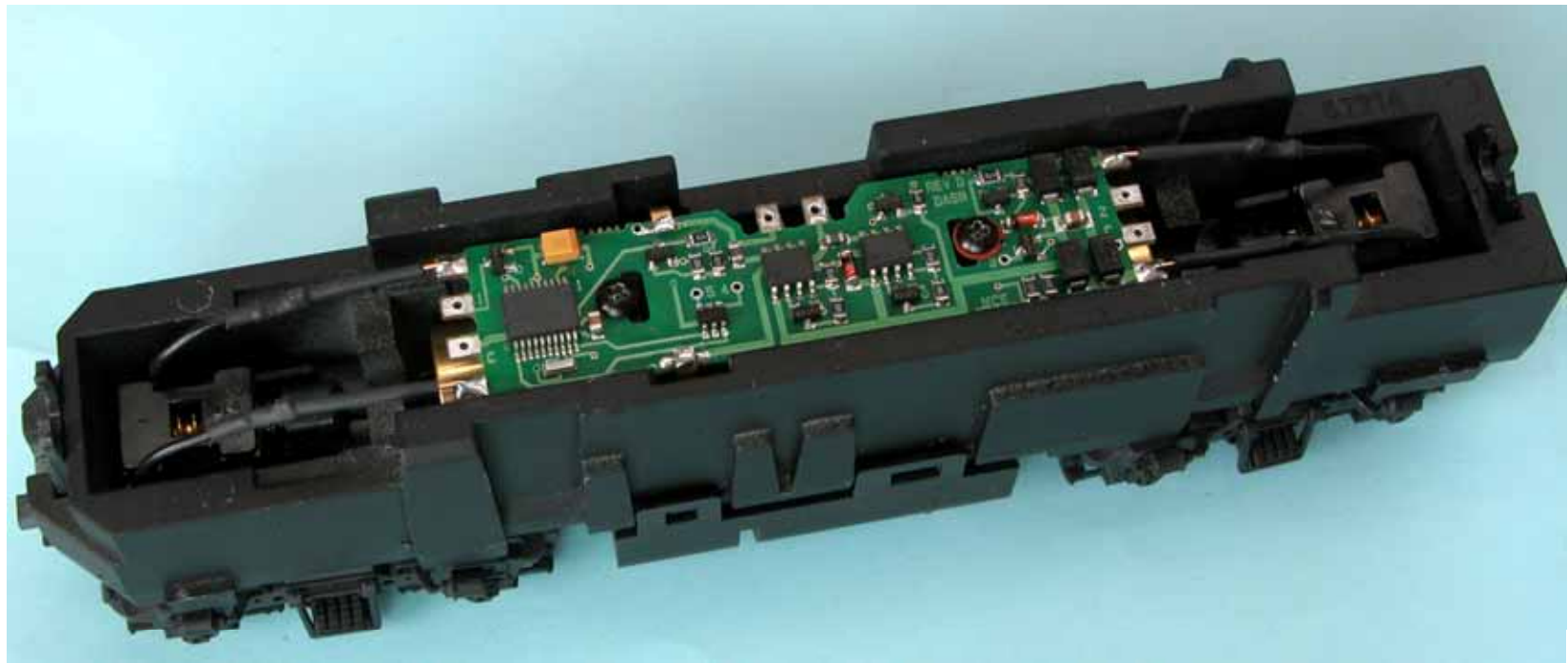

Lighting



Prepare lighting

- A 3mm golden white LED will be used for the upper headlight. Solder a 1000 ohm 1/4W limiting resistor in line as shown.
- For the lower headlight a 0603 surface mount golden white LED will be used. Shown on a small circuit board with 1000 ohm limiting resistor.



Lighting



Upper headlight

- Solder 3mm LED and resistor to the pads on the end of the decoder as shown.
- Anode, or positive side of LED goes to the common pad (C).

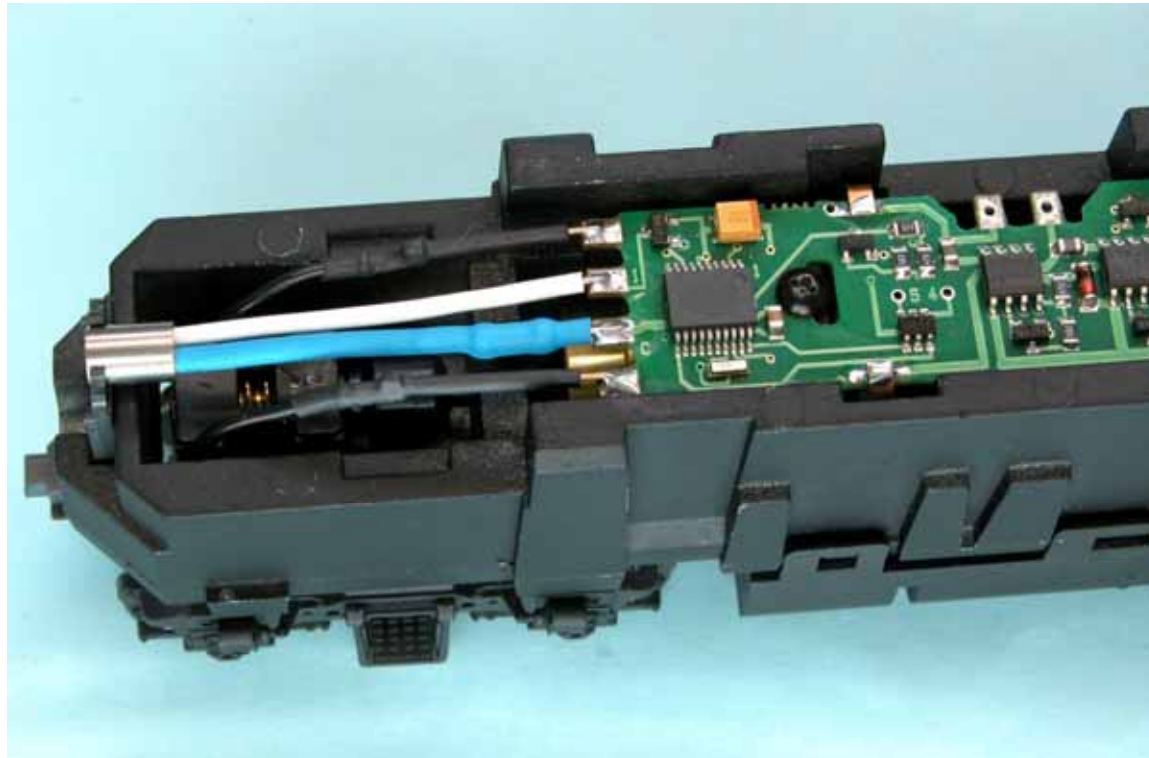

Lighting



Lower headlight

- Secure circuit board in place with double sided foam tape
- Run wires to decoder output #3 and the other common terminal

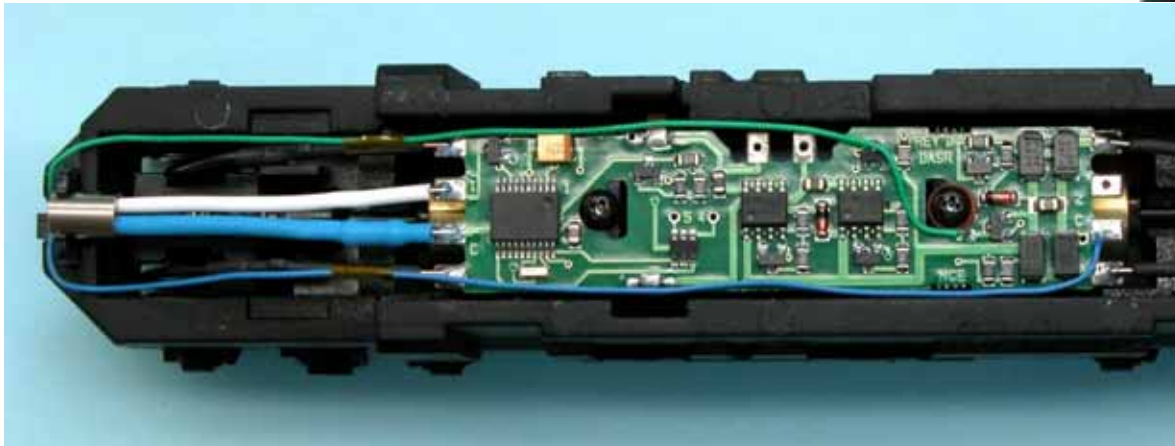
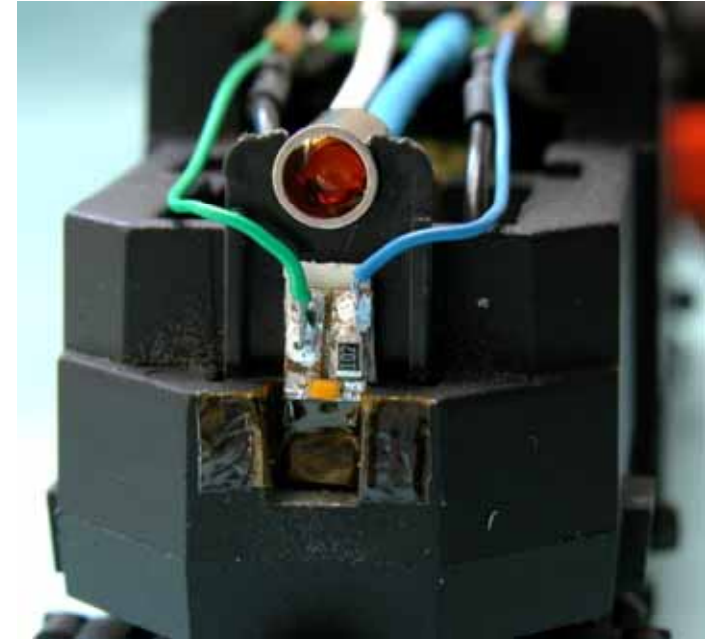

Reinstall Shell



- Reinstall the shell, program, and enjoy your new DCC locomotive.
- LED headlights in the finished installation shown below...



Sound in Steam Locomotives



Sound Decoders

- Sound decoders, Soundtraxx Tsunami, Best in class sound with silent BEMF motor control.
- Installation the same as a regular decoder but with more wires
 - Two additional wires to connect to speaker
 - One wire for optional synchronization cam
- Speaker usually mounted in tender
 - Requires holes to be drilled in tender frame or body
 - Tender shell can act as the speaker enclosure
 - Two wire connector between locomotive and tender
- Optimal chuff synchronization requires a sound cam

Sound Decoder Installation



Tsunami in Boiler

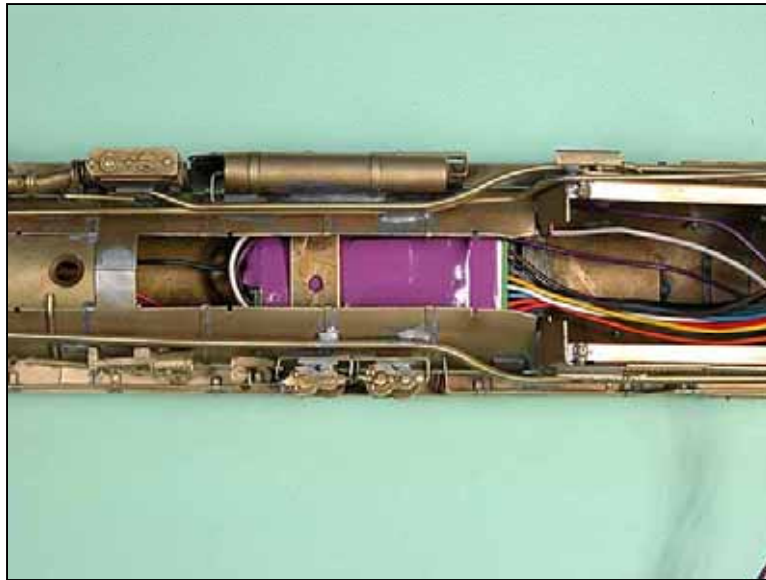

- Decoder tucked up above boiler weight

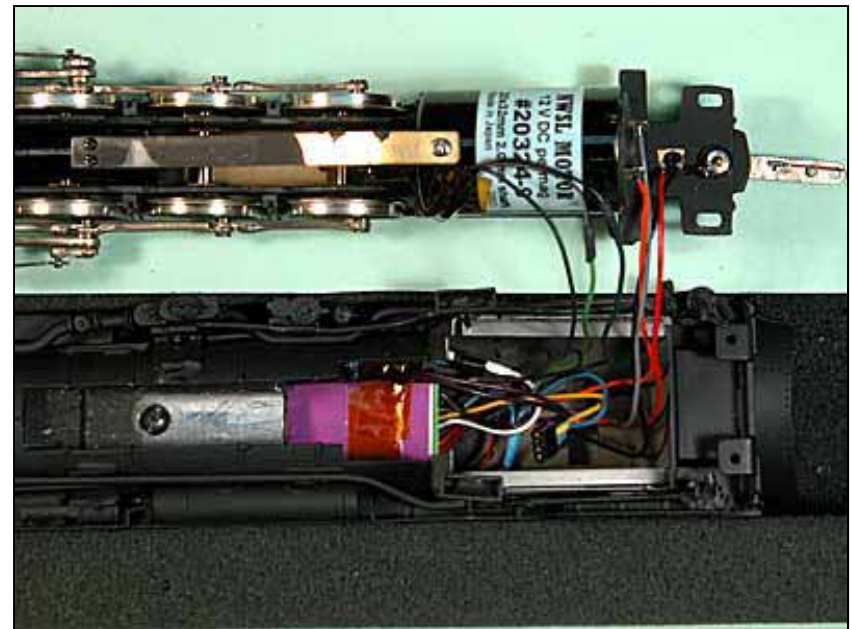

Sound Decoder Installation



Micro Tsunami in a Consolidation

- Decoder tucked up above boiler weight

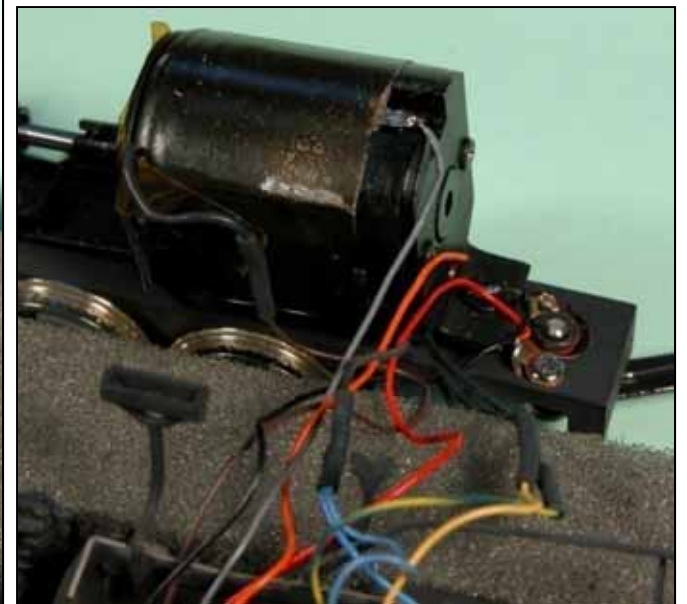
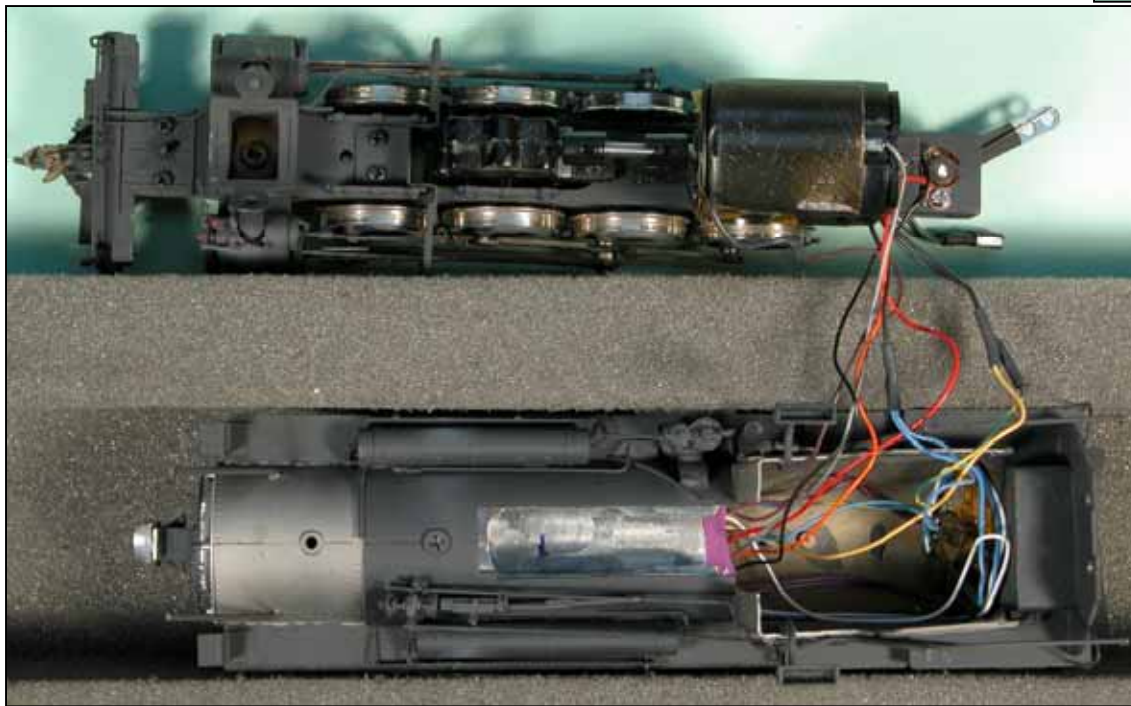
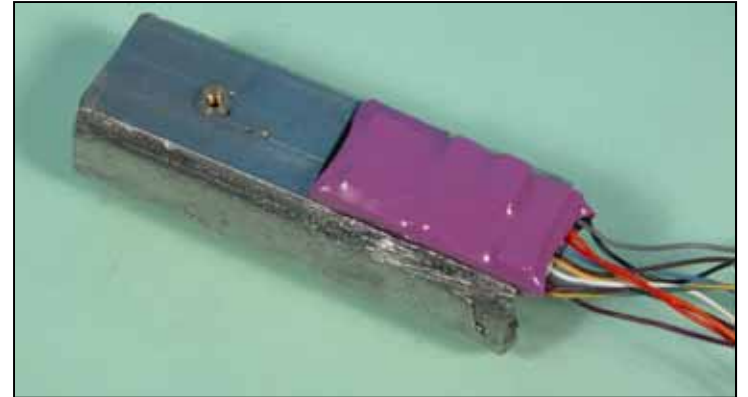

Sound Decoder Installation



Micro Tsunami in a Consolidation

- Keep alive caps in tender



- Speaker in smoke box



Sound Installation



Additional Sound work

- Sound cams



- Sound cam installation
- Make wiper from small circuit board, use phosphor bronze wire for contact

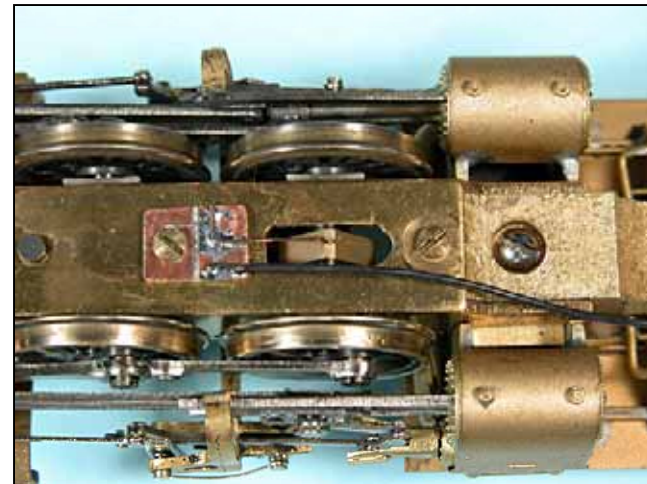
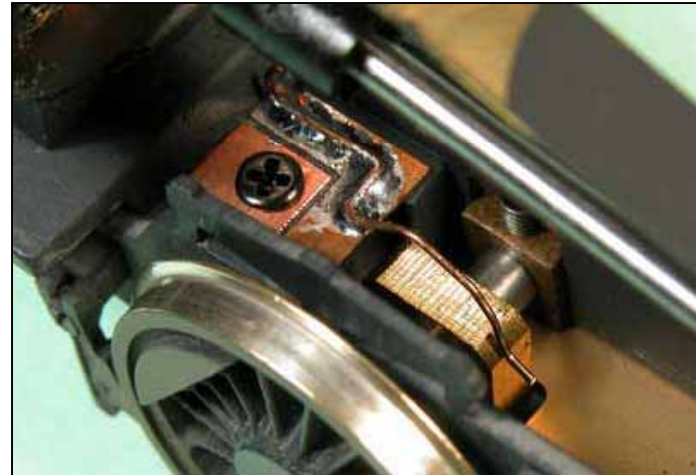

Sound Installation



Other Sound Cam options

- Soundtraxx printed circuit board cams

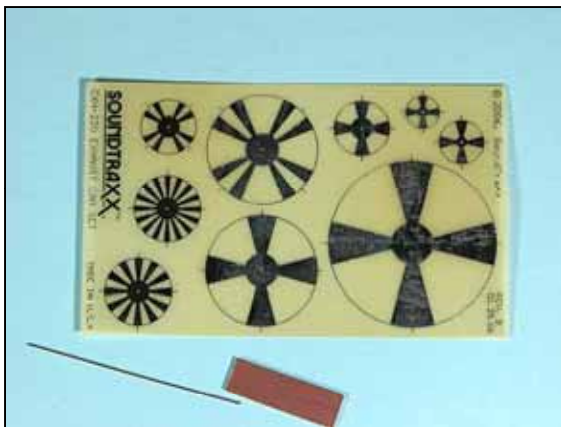

- Grizzly Mountain Engineering Cams, split cams that attached with conductive Epoxy, wiper kits also available
- No driver pulling required with these cams



Sound Installation



Speaker installation

- Usually installed in tender



- Requires drilling hole pattern in tender for sound outlet
- Use the biggest speaker that will fit!

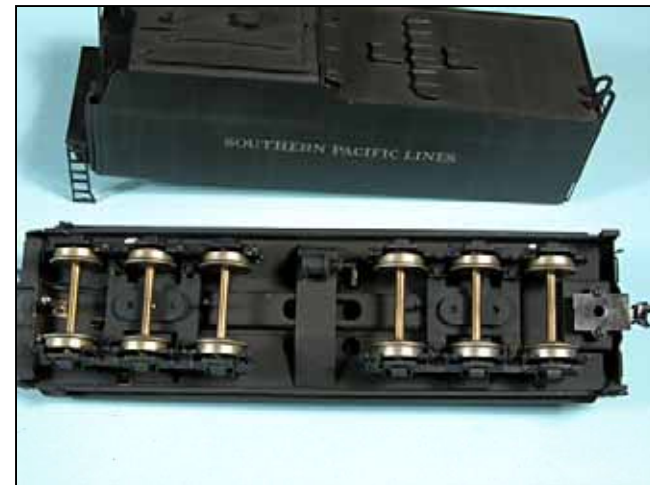

Sound Installation



Speakers

- Another example.



- Small speakers allow for mounting in the boiler.

Sound in Diesel Locomotives



Sound Decoders

- Sound decoders, Soundtraxx Tsunami, QSI, MRC, Digitrax, lots of choices. Tsunami and QSI are the best quality
- Installation the same as a regular decoder but with more wires
 - Two additional wires to connect to speaker
- Speaker usually requires some frame modifications
 - Speaker enclosure is Very important for proper sound levels

Sound in Diesel Locomotives



Tsunami installation in a Proto 2k

- Original light board removed and prepared for decoder installation



Sound in Diesel Locomotives



Test fitting the speaker

- Speaker mounting shown

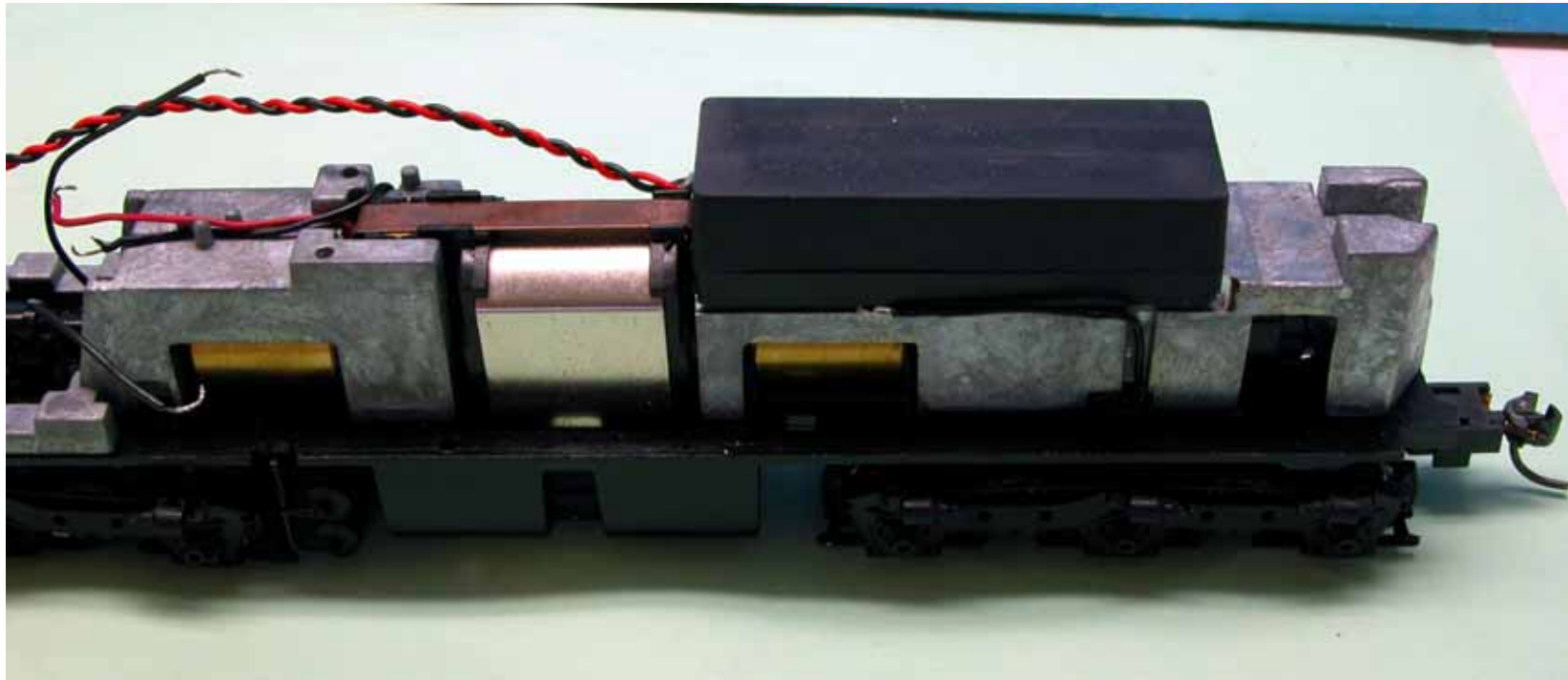

Sound in Diesel Locomotives



Finished installation

- Decoder, speaker, and lights installed





More Steam Examples

Examples



Balboa MT-4, Lenz Gold decoder

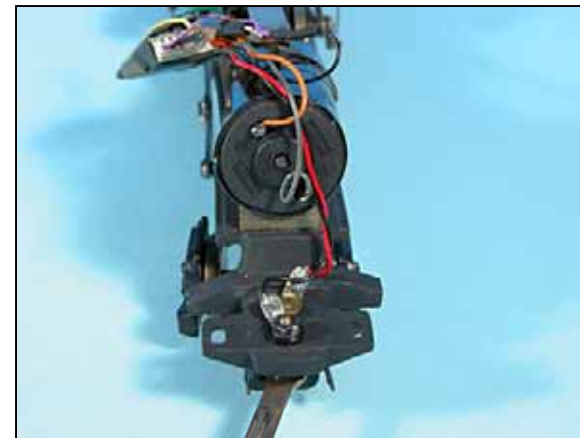
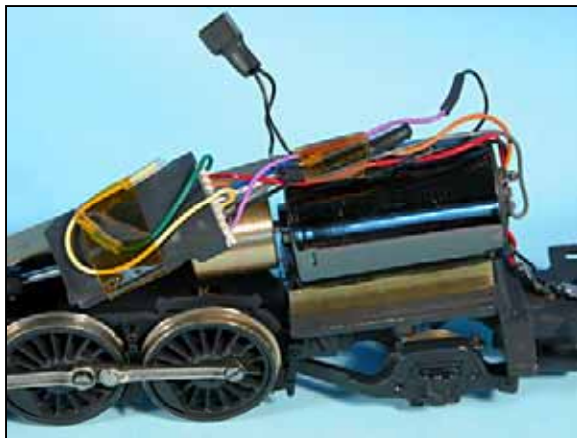
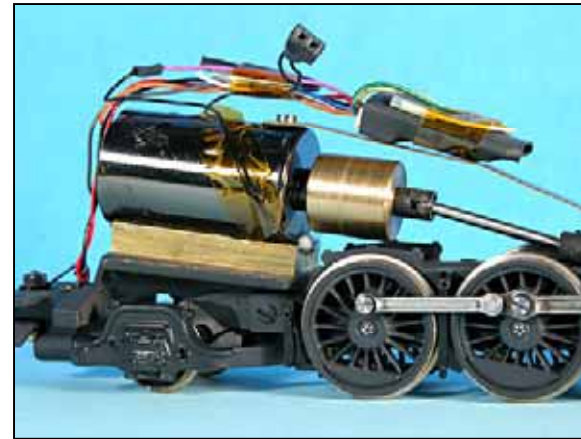
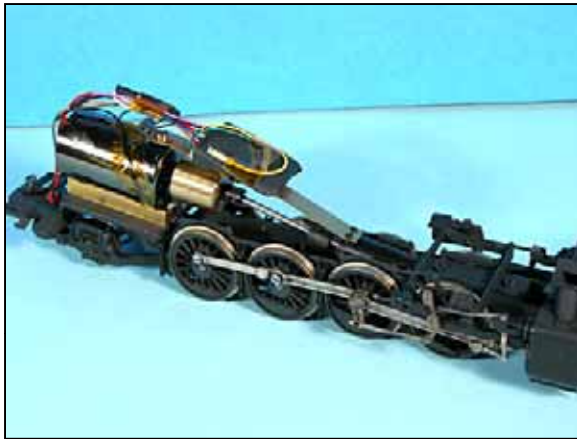

Examples



Max Grey TW-8, N14SR decoder

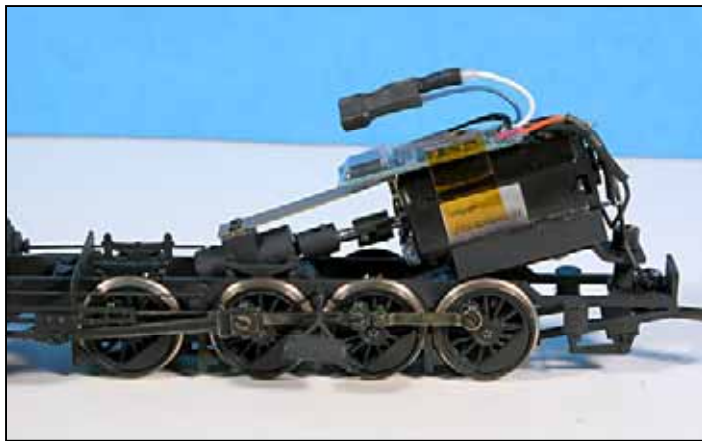

Balboa P-10 #2486, D13SRJ



Westside 0-6-0T, N14SR decoder

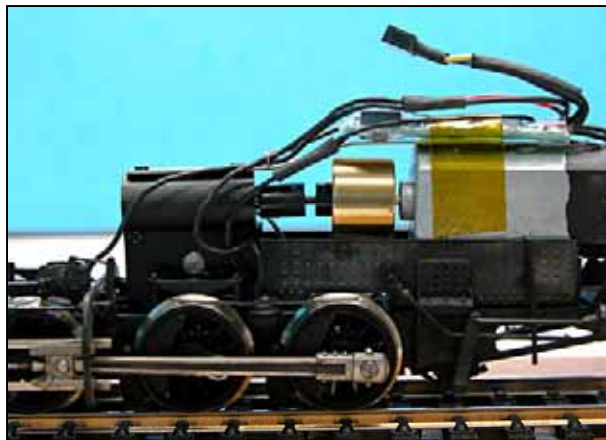

Balboa P-10 #2486, D13SRJ

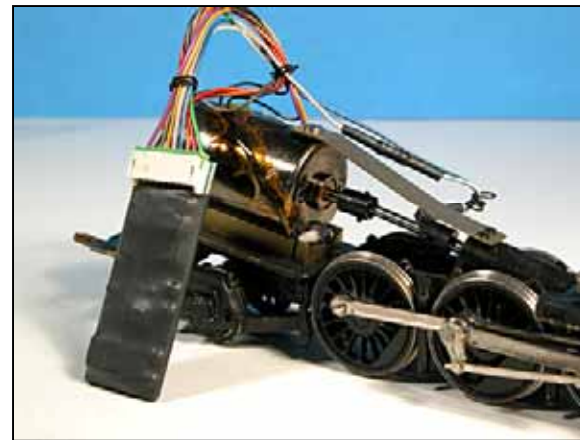

Examples



Tenshodo P-5, N14SR decoder

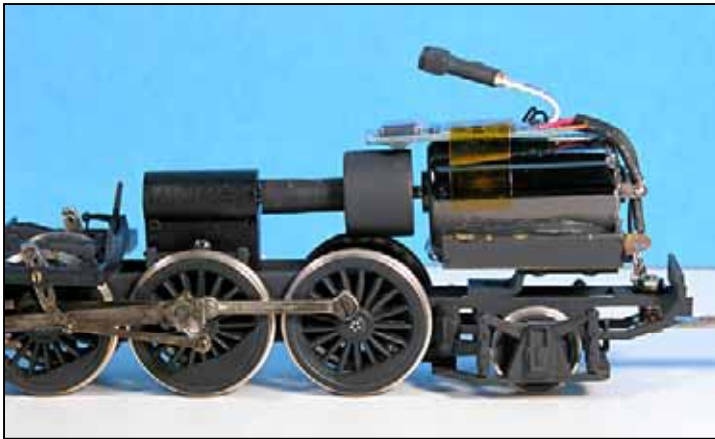

Balboa SE-4, N14SR decoder

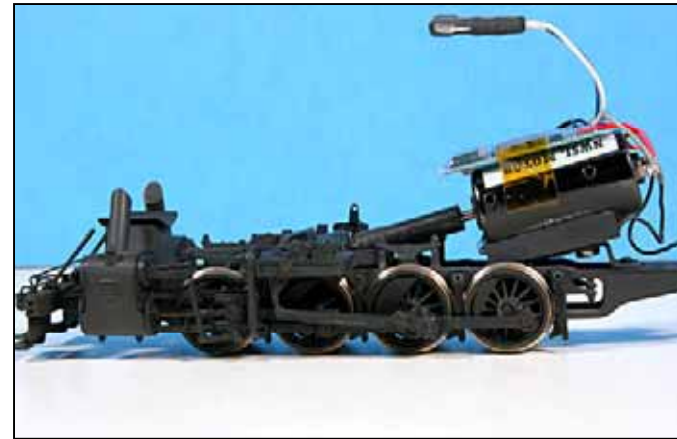

Balboa GS-4, D13SRJ decoder

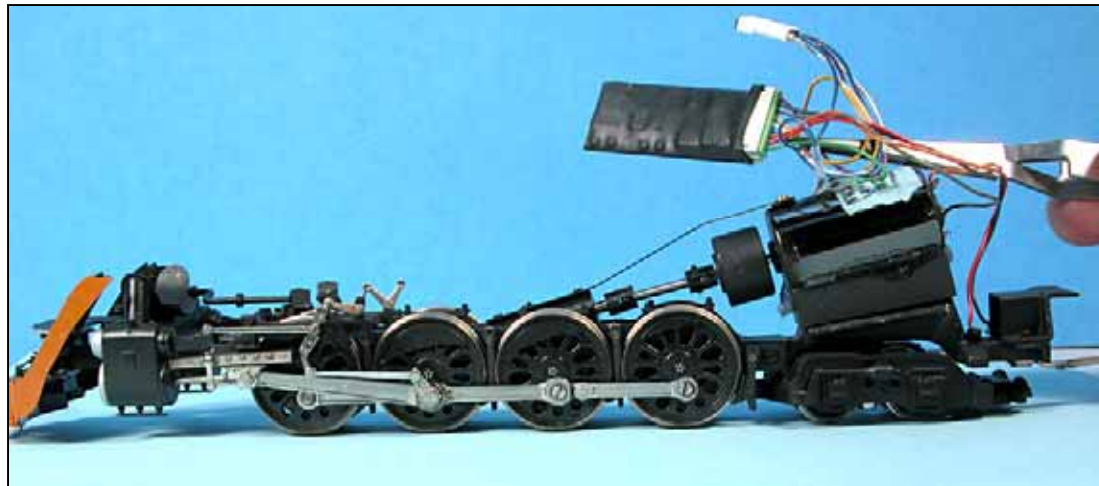



Sources

Sources



Digi-Key Electronics - www.digikey.com

- Resistors
- Heat Shrink tubing
 - Various different sizes, 3/32", 1/16", 1/8", 3/16", etc.
- Pin strip headers / sockets
 - 40 pin 2mm header strip, part number S5800-40-ND
 - 40 pin 2mm socket strip, part number S5751-40-ND
- Kapton tape
- Speakers

Miniatronics - www.miniatronics.com

- Miniature connectors
- Various miniature bulbs, 1.5 volt, 12 volt, and 14 volt flavors

Richmond Controls - www.richmondcontrols.com

- Sunny white and golden white LED's, 3mm and 5mm diameter

Sources



Grizzly Mountain Engineering – www.g-m-e.com

- Sound cams
- Sound pickup wipers
- 2 Pin strip headers / sockets
- Speakers

Soundtraxx - www.soundtraxx.com

- Decoders, Tsunami, Micro Tsunami
- PC board sound cams
- Speakers



Questions?